

Ersatzteilzeichnung spare parts driStar 14/18

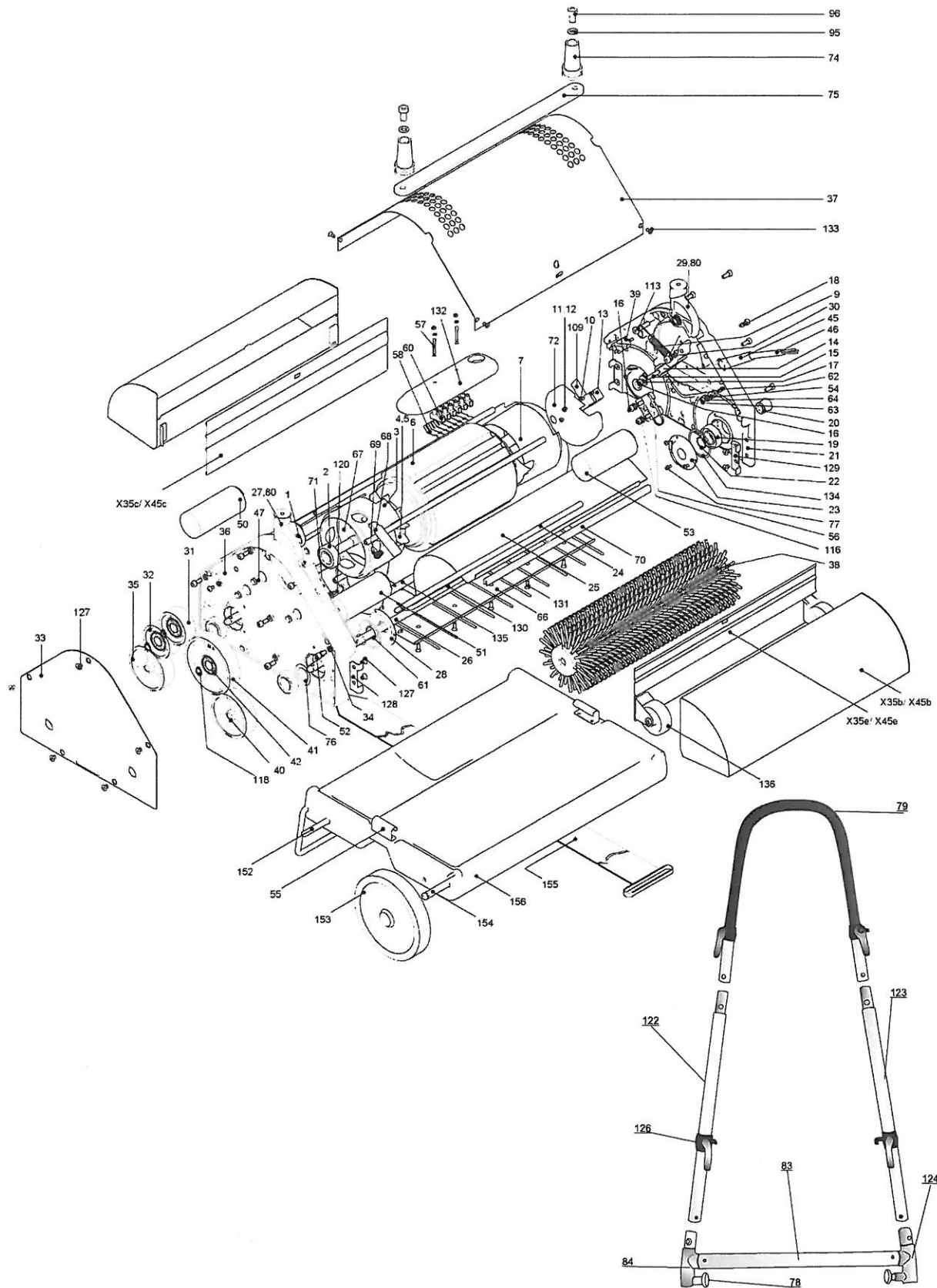

Ersatzteilliste spare driStar 14/18

Nr.	Bezeichnung	description	Nr.	Bezeichnung	description
PRO35:					
G 1	Sicherungsring A 12	Snapping A12	G 60	Klemmleiste EKL 1	Terminal EKL 1
G 2	Kugellager 6002	Ball bearing 6002	G 61	V-Ring	V-Ring
G 3	Zwischenstück G	Distancepiece G	G 62	Gewindestift	Wormscrew
G 4	Spannstift	Split pin	G 63	Mutter	Nut
G 5	Lüfterrad	Ventilator	G 64	Zahnscheibe	Lockwasher
G 6	Motor	Motor	G 66	Kabelfang	Cableprotector
G 7	Zwischenstück E	Distancepiece E	G 67	Blende	Blind
G 9	Zugfeder	Extension spring	G 68	Stielsperre Alu	Handle stop
G 10	Gewindestift	Worm screw	G 69	Feder f. Stielsperre	Handle stop-spring
G 11	Mutter	Nut	G 70	Schaumstoffdichtung	Foamed plastic strip
G 12	Federring	Spring ring	G 71	Sicherungsring A 15	Snapping A 15
G 13	Mikroschalter	Microswitch	G 72	Schalterabdeckung	Switchcover
G 14	Schalthebel kpl.	Switchpart cpl.	G 74	Stielansatzoberteil	Handle connector upper part
G 15	Gewindestift	Worm screw	G 75	Flachstange	Flatbar
G 16	Mutter	Nut	G 76	Anlaufscheibe	Washer disc
G 17	Scheibe	Washer	G 77	Gewindeschraube f. Fadenschutz	Screw for protective plate
G 18	Zylinderschraube Gehäuseblock	Screw for housing unit	G 78	Zugschnäpper	Snap-in
G 19	Kugellager 6003	Ball bearing 6003	G 79	Stiel Oberteil	Handle upper part
G 20	Flansch	Flange	G 80	Lagerbuchse	Bearing
G 21	Gehäuseblock E kpl.	Housing unit E cpl.	G 83	Querrohr	Cross bar
G 22	Sicherungsring A 17	Retainingring A 17	G 84	Stielknoten links, kpl	T-piece left cpl.
G 23	Fadenschutz	Protective plate	G 86	Tandemstange	Tandem bar
G 24	Zugstange	Motorstud	G 88	Stiel kpl	Handle cpl
G 25	Bürstabdeckung, innen	Brushcover, interior	G 95	Federring	Spring ring
G 26	Steckachse	Brush axle	G 96	Zylinderschraube	Cylinder head screw
G 27	Stielansatzunterteil G	Handle connector lower part G	G 109	Isolierplättchen	Isolation plate
G 28	Fadenschutz	Protective plate	G 113	Zylinderschraube	Cylinder head screw
G 29	Stielansatzunterteil E	Handle connector lower part E	G 116	Federring	Spring ring
G 30	Schraube M6x16	Screw M6x16	G 118	Sicherungsring A 10	Snapping A 10
G 31	Zahnrad 48 re	Gear 48 right	G 120	Schraube M6x16	Screw M6x16
G 32	Zahnrad 48 li	Gear 48 left	G 122	Stielunterteil	Handle lower part
G 33	Getriebedeckel	Gearcover	G 123	Stielunterteil	Handle lower part
G 34	Zahnscheibe	Lockwasher	G 124	Stielknoten rechts kpl.	T-piece right cpl.
G 35	Zahnrad 66 re	Gear 66 right	G 126	Kabelhaken schwenkbar	360° rotating cableholder
G 36	Gehäuseblock G kpl.	Housing unit G cpl.	G 127	Senkkopfschraube M5x6	Countersunk head screw M5x6
G 37	Abdeckhaube	Motor cover	G 128	Halter links	Holder left
G 38	Ersatzbürsten	Brushes	G 129	Halter rechts	Holder right
G 39	Motorschutzschalter	Thermorelay	G 130	Einwurfbeschleuniger	Throw-in accelerator
G 40	Zahnrad 66 li	Gear 66 left	G 131	Sechskopfschraube M4x12	Countersunk head screw M4x12
G 41	Zahnrad 85 re	Gear 85 right	G 132	Spritzschutz	Protective cover
G 42	Kugellager 6000	Ball bearing 6000	G 133	Senkkopfschraube M4x8	Countersunk head screw M4x8
G 45	Tülle	Grommet	G 134	O - Ring	O - Ring
G 46	Kabel	Cable	G 135	Sechskantstange f. Kabelschutz	Hexagonbar cableprotector
G 47	Lagerbolzen	Bearingpin	G 136	Rad für Bürstabdeckung kpl.	Wheel for brushcover exterior cpl
G 49	Zylinderschraube M4x8	Cylinder head screw M4x8	G 152	Stehbügel	Front upright
G 50	Betriebskondensator	Run Capacitor	G 153	Rad, groß	Wheel, big
G 51	Startkondensator	Start Capacitor	G 154	Achse für Transportwagen	Axle for transport trolley
G 52	Zylinderschraube	Cylinder head screw	G 155	Gurt kpl. mit Blindnieten	Fixing belt for trolley, cpl.
G 53	Anlaufsteuerung	Starting control unit	G 156	Tasse mit Haltefeder	Tray incl. clips
G 54	Klemmschiene	Clamp strip	G 157	Zugspanner kpl.	Fixation buckle cpl.
G 55	Haltefeder inkl. Nieten kpl.	Clip trolley incl. 2 blind rivets	X 35b	Renovator	Renovator
G 56	Klemmbacke	Cable clamp	X 35c	Staubschutz	Dustcover
G 57	Zylinderschraube M3x25	Cylinder head screw M3x25	X 35e	Staubschutz mit Räder	Dustcover with wheels
G 58	Drahthalterplatte	Wire fixing plate			

100

95

75

25

5

0

Ersatzteilliste spare driStar 14/18

Nr.	Bezeichnung	description	Nr.	Bezeichnung	description
PRO45:					
G 1	Sicherungsring A 12	Snapping A12	G 60	Klemmleiste EKL 1	Terminal EKL1
G 2	Kugellager 6002	Ball bearing 6002	G 61	V-Ring	V-Ring
G 3-45	Zwischenstück G	Distancepiece G	G 62	Gewindestift	Wormscrew
G 4	Spannstift	Split pin	G 63	Mutter	Nut
G 5	Lüfterrad	Ventilator	G 64	Zahnscheibe	Lockwasher
G 6-45	Motor	Motor	G 66-45	Kabelfang	Cableprotector
G 7-45	Zwischenstück E	Distancepiece E	G 67	Blende	Blind
G 9	Zugfeder	Extension spring	G 68	Stielsperre Alu	Handle stop
G 10	Gewindestift	Worm screw	G 69	Feder f. Stielsperre	Handle stop-spring
G 11	Mutter	Nut	G 70-45	Schaumstoffdichtung	Foamed plastic strip
G 12	Federring	Spring ring	G 71	Sicherungsring A 15	Snapping A 15
G 13	Mikroschalter	Microswitch	G 72	Schalterabdeckung	Switchcover
G 14	Schalthebel kpl.	Switchpart cpl.	G 74	Stielansatzoberteil	Handle connector upper part
G 15	Gewindestift	Worm screw	G 75-45	Flachstange	Flatbar
G 16	Mutter	Nut	G 76	Anlaufscheibe	Washer disc
G 17	Scheibe	Washer	G 77	Gewindeschraube f. Fadenschutz	Screw for protective plate
G 18	Zylinderschraube Gehäuseblock	Screw for housing unit	G 78	Zugschnäpper	Snap-in
G 19	Kugellager 6003	Ball bearing 6003	G 79	Stiel Oberteil	Handle upper part
G 20	Flansch	Flange	G 80	Lagerbuchse	Bearing
G 21	Gehäuseblock E kpl.	Housing unit E cpl.	G 83-45	Querrohr	Cross bar
G 22	Sicherungsring A 17	Retainingring A 17	G 84	Stielknoten links, kpl	T-piece left cpl.
G 23	Fadenschutz	Protective plate	G 86-45	Tandemstange	Tandem bar
G 24-45	Zugstange	Motorstud	G 88-45	Stiel kpl	Handle cpl
G 25-45	Bürstabdeckung, innen	Brushcover, interior	G 95	Federring	Spring ring
G 26-45	Steckachse	Brush axle	G 96	Zylinderschraube	Cylinder head screw
G 27	Stielansatzunterteil G	Handle connector lower part G	G 109	Isolierplättchen	Isolation plate
G 28	Fadenschutz	Protective plate	G 113	Zylinderschraube	Cylinder head screw
G 29	Stielansatzunterteil E	Handle connector lower part E	G 116	Federring	Spring ring
G 30	Schraube M6x16	Screw M6x16	G 118	Sicherungsring A 10	Snapping A 10
G 31	Zahnrad 48 re	Gear 48 right	G 120	Schraube M6x16	Screw M6x16
G 32	Zahnrad 48 li	Gear 48 left	G 122	Stielunterteil	Handle lower part
G 33	Getriebedeckel	Gearcover	G 123	Stielunterteil	Handle lower part
G 34	Zahnscheibe	Lockwasher	G 124	Stielknoten rechts kpl.	T-piece right cpl.
G 35	Zahnrad 66 re	Gear 66 right	G 126	Kabelhaken schwenkbar	360° rotating cableholder
G 36	Gehäuseblock G kpl.	Housing unit G cpl.	G 127	Senkkopfschraube M5x6	Countersunk head screw M5x6
G 37-45	Abdeckhaube	Motor cover	G 128	Halter links	Holder left
G 38	Ersatzbürsten	Brushes	G 129	Halter rechts	Holder right
G 39	Motorschutzschalter	Thermorelay	G130-45	Einwurfbeschleuniger	Throw-in accelerator
G 40	Zahnrad 66 li	Gear 66 left	G 131	Sechskopfschraube M4x12	Countersunk head screw M4x12
G 41	Zahnrad 85 re	Gear 85 right	G 132	Spritzschutz	Protective cover
G 42	Kugellager 6000	Ball bearing 6000	G 133	Senkkopfschraube M4x8	Countersunk head screw M4x8
G 45	Tülle	Grommet	G 134	O - Ring	O - Ring
G 46	Kabel	Cable	G135-45	Sechskantstange f. Kabelschutz	Hexagonbar cableprotector
G 47	Lagerbolzen	Bearingpin	G 136	Rad für Bürstabdeckung kpl.	Wheel for brushcover exterior cpl.
G 49	Zylinderschraube M4x8	Cylinder head screw M4x8	G152-45	Stehbügel	Front upright
G 50	Betriebskondensator	Run Capacitor	G 153	Rad, groß	Wheel, big
G 51	Startkondensator	Start Capacitor	G154-45	Achse für Transportwagen	Axle for transport trolley
G 52	Zylinderschraube	Cylinder head screw	G 155	Gurt kpl. mit Blindnieten	Fixing belt for trolley, cpl.
G 53	Anlaufsteuerung	Starting control unit	G156-45	Tasse mit Haltefeder	Tray incl. clips
G 54	Klemmschiene	Clamp strip	G 157	Zugspanner kpl.	Fixation buckle cpl.
G 55	Haltefeder inkl. Nieten kpl.	Clip trolley incl. 2 blind rivets	X 45b	Renovator	Renovator
G 56	Klemmbacke	Cable clamp	X 45c	Staubschutz	Dustcover
G 57	Zylinderschraube M3x25	Cylinder head screw M3x25	X 45e	Staubschutz mit Räder	Dustcover with wheels
G 58	Drahthalterplatte	Wire fixing plate			

100

95











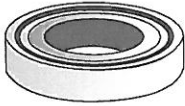

75

25





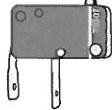
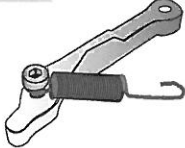

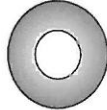

5

0

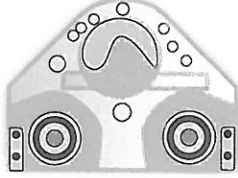

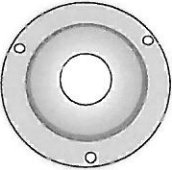
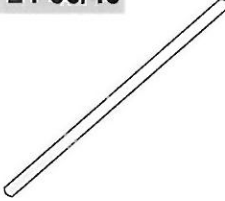
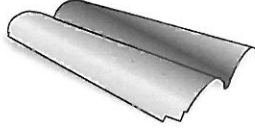

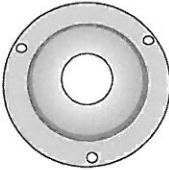

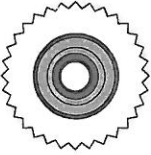
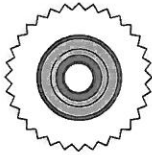
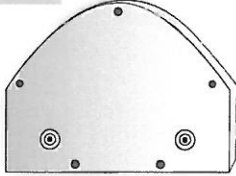
Ersatzteile - spare parts driStar 14/18

<p>1</p> 	<p>2</p> 	<p>3 -35 / 3 -45</p> 	<p>4</p> 
<p>Sicherungsring A 12 Snarpring A 12</p>	<p>Kugellager Ballbearing</p>	<p>Zwischenstück G Distancepiece G</p>	<p>Spannstift 3 x 20 A2 Split pin 3 x 20 A2</p>
<p>5</p> 	<p>6 -35 / 6 -45</p> 	<p>7 -35 / 7 -45</p> 	<p>9</p> 
<p>Lüfterrad Ventilator</p>	<p>Motor RBF 0,18/2-PR Motor RBF 0,18/2-PR</p>	<p>Zwischenstück E Distancepiece E</p>	<p>Zugfeder 10x 1,2 x 64 Extension spring 10x 1,2 x 64</p>
<p>10</p> 	<p>11</p> 	<p>12</p> 	<p>13</p> 
<p>Gewindestift M3 x 40 worm screw M3 x 40</p>	<p>Mutter M3 Ms Nut M3 Ms</p>	<p>Federring M3 Spring Ring M3</p>	<p>Microschalter Microswitch</p>
<p>14</p> 	<p>15</p> 	<p>16</p> 	<p>17</p> 
<p>Schalthebel kpl. Switchpart cpl.</p>	<p>Gewindestift M5x 25 worm screw M5 x 25</p>	<p>Mutter M5 Nut M5</p>	<p>Scheibe M5 Washer M5</p>

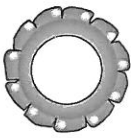
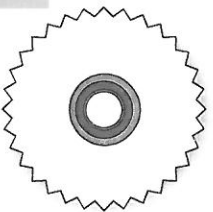
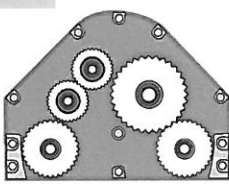
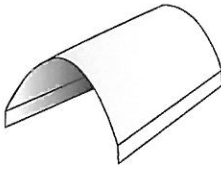
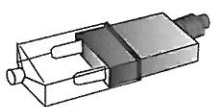
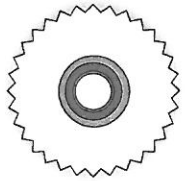
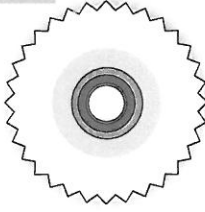
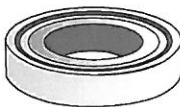
Ersatzteile - spare parts driStar 14/18

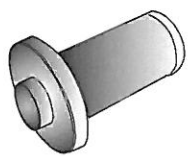

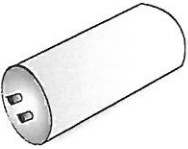
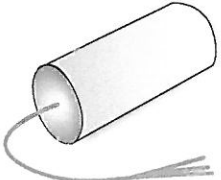

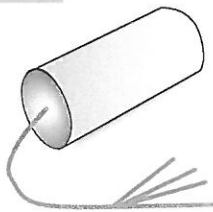





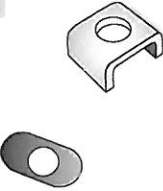
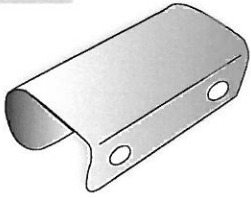
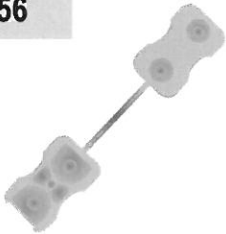

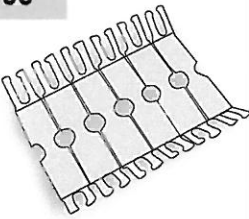
<p>18</p> 	<p>19</p> 	<p>20</p> 	<p>21</p> 
<p>Zylinderschraube M5 x 12 Cylinder head screw M5 x 12</p>	<p>Rillenkugellager Ballbearing</p>	<p>Flansch Flange</p>	<p>Gehäuseblock E komplett Housing unit E complet</p>
<p>22</p> 	<p>23</p> 	<p>24-35/45</p> 	<p>25-35/45</p> 
<p>Sicherungsring A 17 Snapping A 17</p>	<p>Fadenschutz Protective plat</p>	<p>Zugstange Motorstud</p>	<p>Bürstabweckung innen Brushcover interior</p>
<p>26-35/45</p> 	<p>27</p> 	<p>28</p> 	<p>29</p> 
<p>Steckachse Brush axle</p>	<p>Stielansatz Unterteil G Handle connector lower part G</p>	<p>Fadenschutz Protective plat</p>	<p>Stielansatz Unterteil E Handle connector lower part E</p>
<p>30</p> 	<p>31</p> 	<p>32</p> 	<p>33</p> 
<p>Zylinderschraube M6 x 16 Cylinder head screw M6 x 16</p>	<p>Zahnrad 48 rechts Gear 48 right</p>	<p>Zahnrad 48 links Gear 48 left</p>	<p>Getriebedeckel Gearcover</p>

Ersatzteile - spare parts driStar 14/18

<p>34</p> 	<p>35</p> 	<p>36</p> 	<p>37-35/45</p> 
<p>Zahnscheibe M5 Lock washer M5</p>	<p>Zahnrad 66 rechts Gear 66 right</p>	<p>Gehäuseblock G komplett Housing unit G cpl.</p>	<p>Motorhaube motor cover</p>
<p>39</p> 	<p>40</p> 	<p>41</p> 	<p>42</p> 
<p>Motorschutzschalter Thermorelay</p>	<p>Zahnrad 66 links Gear 66 left</p>	<p>Zahnrad 85 rechts Gear 85 right</p>	<p>Rillenkugellager Ballbearing</p>
<p>45</p> 	<p>46</p> 	<p>47</p> 	<p>49</p> 
<p>Tülle Grommet</p>	<p>Kabel Cable</p>	<p>Lagerbolzen Bearingpin</p>	<p>Zylinderschraube M4 x 8 Cylinder head screw M4 x 8</p>
<p>50</p> 	<p>51</p> 	<p>52</p> 	<p>53</p> 
<p>Betriebskondensator Run capacitor</p>	<p>Startkondensatorkondensator Start capacitor</p>	<p>Zylinderschraube M5 x 12 Cylinder head screw M5 x 12</p>	<p>Anlaufsteuerung Starting control unit</p>

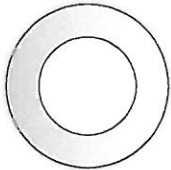
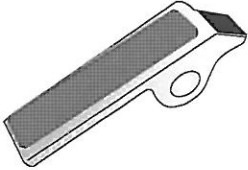

Ersatzteile - spare parts driStar 14/18

<p>54</p> 	<p>55</p> 	<p>56</p> 	<p>57</p> 
<p>Klemmbügel-/Schiene Clamp strip</p>	<p>Haltefeder für Transportwagen Fixing spring for trolley</p>	<p>Klemmbacke Cable clamp</p>	<p>Zylinderschraube M3 x 25 Cylinder head screw M3 x 25</p>
<p>58</p> 	<p>60</p> 	<p>61</p> 	<p>62</p> 
<p>Drahalteplatte wire fixing plate</p>	<p>Klemmleiste terminal</p>	<p>V-Ring V-ring</p>	<p>Gewindestift Worm screw</p>
<p>63</p> 	<p>64</p> 	<p>66 -35 / 66 -45</p> 	<p>67</p> 
<p>Mutter M4 Nut M4</p>	<p>Zahnscheibe M4 A2 Lock washer M4 A2</p>	<p>Kabelfang Cableprotector</p>	<p>Blende Blind</p>
<p>68</p> 	<p>69</p> 	<p>70 -35 / 70 -45</p> 	<p>71</p> 
<p>Stielsperre Alu Handle stop</p>	<p>Feder für Stielsperre Handle stop - spring</p>	<p>Schaumstoffdichtung Foamed plastic strip</p>	<p>Sicherungsring A 15 Snapping A 15</p>

Ersatzteile - spare parts driStar 14/18

<p>72</p> 	<p>74</p> 	<p>75 -35 / 75 -45</p> 	<p>E 76</p> 
<p>Schalterabdeckung Switchcover</p>	<p>Stielansatzoberteil Handle connector upper part</p>	<p>Flachstange Flatbar</p>	<p>Anlaufscheibe Washer</p>
<p>77</p> 	<p>78</p> 	<p>79</p> 	<p>80</p> 
<p>Schraube M3 x 5 Screw M3 x 5</p>	<p>Zugschnapper Snap - in</p>	<p>Stiel Oberteil Handle, upper part</p>	<p>Lagerbuchse Bearing</p>
<p>83 -35 / 83 -45</p> 	<p>84</p> 	<p>86-35/45</p> 	<p>88-35/45</p> 
<p>Querrohr Cross bar</p>	<p>Stielknoten links T-piece left</p>	<p>Tandemstange Tandem bar</p>	<p>Stiel komplett Handle complete</p>
<p>95</p> 	<p>96</p> 	<p>106</p> 	<p>113</p> 
<p>Federring M6 Spring Ring M6</p>	<p>Schraube M6 x 30 Screw M6 x 30</p>	<p>Isolierplättchen Isolating plate</p>	<p>Zylinderschraube M6 x 16 Cylinder head screw M6 x 16</p>

100

45













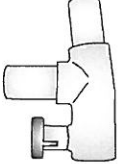
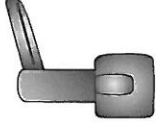

75

25

5

0

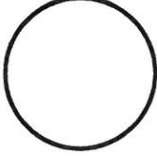
Ersatzteile - spare parts driStar 14/18

<p>116</p> 	<p>118</p> 	<p>120</p> 	<p>122</p> 
<p>Federring Spring Ring</p>	<p>Sicherungsring A 10 Snapping A 10</p>	<p>Schraube M6 x 16 Screw M6 x 16</p>	<p>Stielunterteil links Handle, lower part left</p>
<p>123</p> 	<p>124</p> 	<p>126</p> 	<p>127</p> 
<p>Stielunterteil rechts Handle, lower part right</p>	<p>Stielknoten rechts T-piece right</p>	<p>Kabelhaken schwenkbar Cable holder slewable</p>	<p>Senkkopfschraube M5 x 6 Countersunk-head screw M5 x 6</p>
<p>128</p> 	<p>129</p> 	<p>130 -35 / 130 -45</p> 	<p>131</p> 
<p>Halter links Holder left</p>	<p>Halter rechts Holder right</p>	<p>Einwurfbeschleuniger Throw-in accelerator</p>	<p>Senkkopfschraube M4 x 12 Countersunk-head screw M4 x 12</p>
<p>132</p> 	<p>133</p> 	<p>134</p> 	<p>135 -35 / 135 -45</p> 
<p>Spritzschutz Protective cover</p>	<p>Senkkopfschraube M4 x 8 Countersunk-head screw M4 x 8</p>	<p>O-Ring O-ring</p>	<p>Sechskantstange Hexagon bar</p>

100
95
75
25
5
0

Ersatzteile - spare parts driStar 14/18

136



Rad für Bürstenabdeckung
Wheel for brushcover

152 -35 / 152 -45



Stehbügel
Front upright

153



Rad Transportwagen
Wheel Trolley

154 -35 / 154 -45



Radachse
Axel

155



Gurt
Belt

156

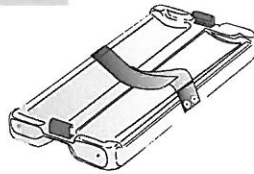

Transporttasse inkl. Hallefeder und Gurt
Tray incl. clips and belt

157

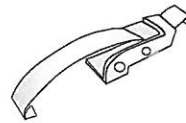

Zugspanner kpl.
Fixation buckle cpl.

100

95

75

25

5

0