

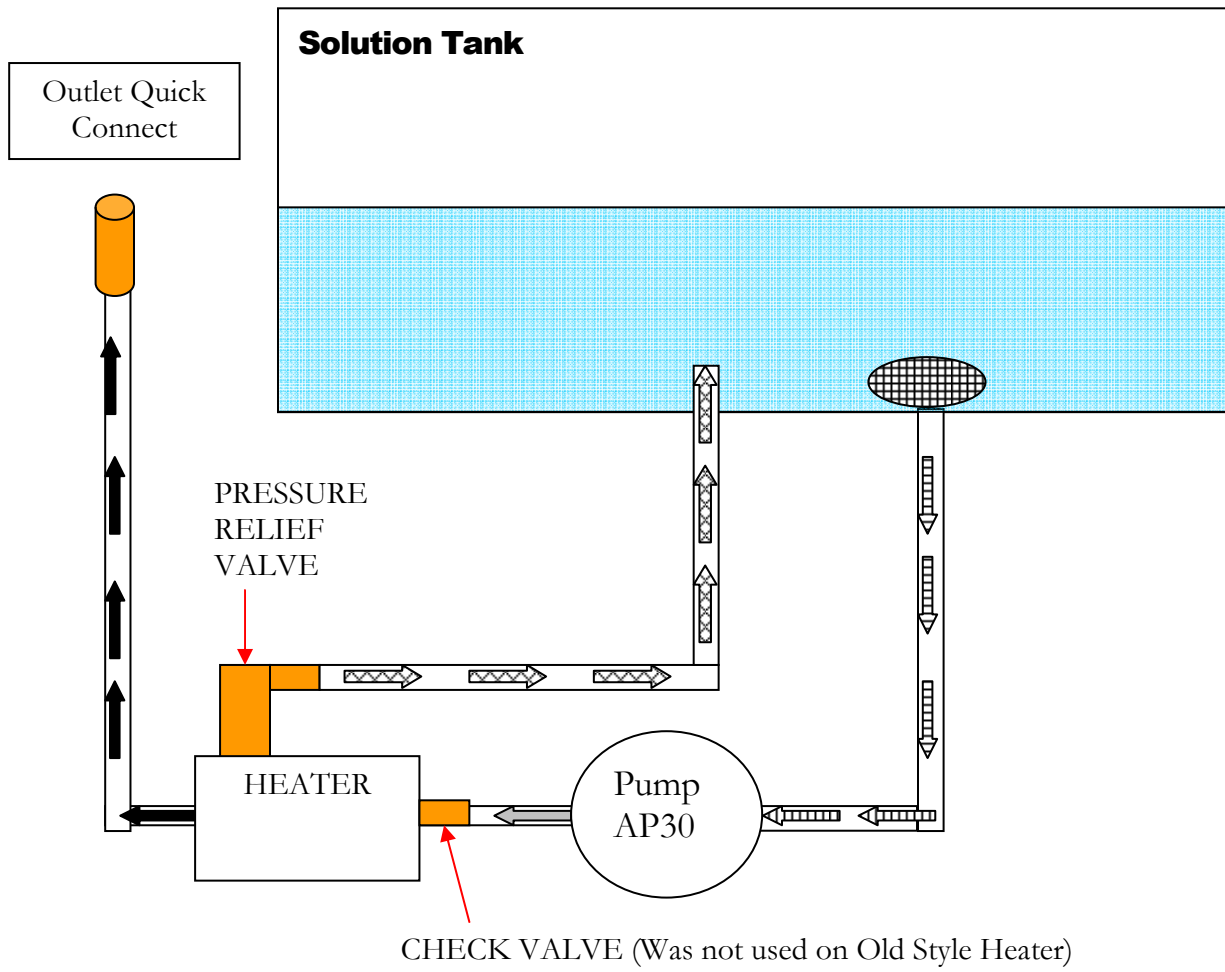

MA51H

Solution Flow Path



Denotes incoming water flow



Denotes Cold Water flow in pressure hose



Denotes Heated Water flow in pressure hose



Denotes Heated Water by-pass flow from heater pressure relief



MA51H

Wiring Diagram with Heater

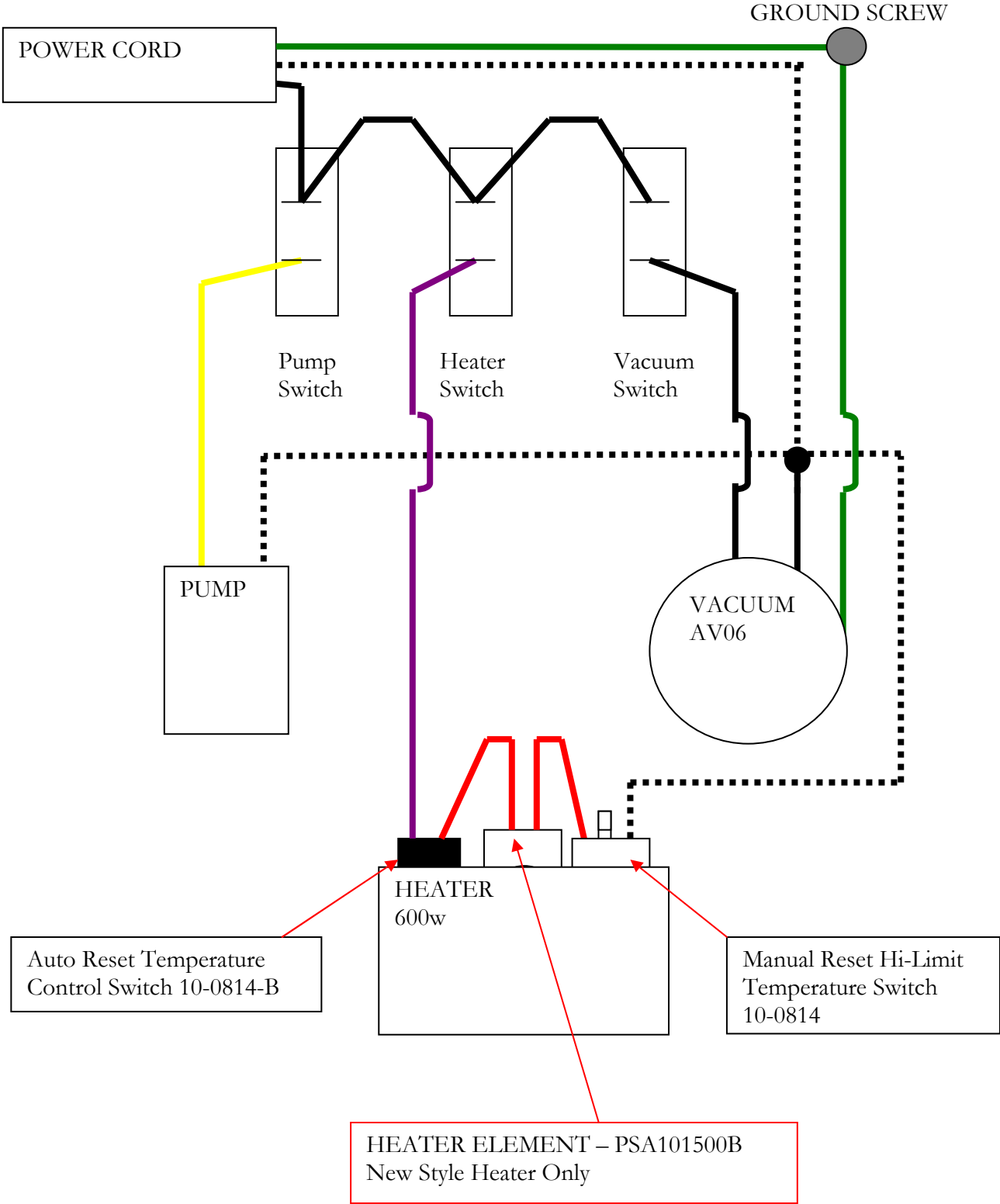

MA51H with HEATER SWITCH PANEL:

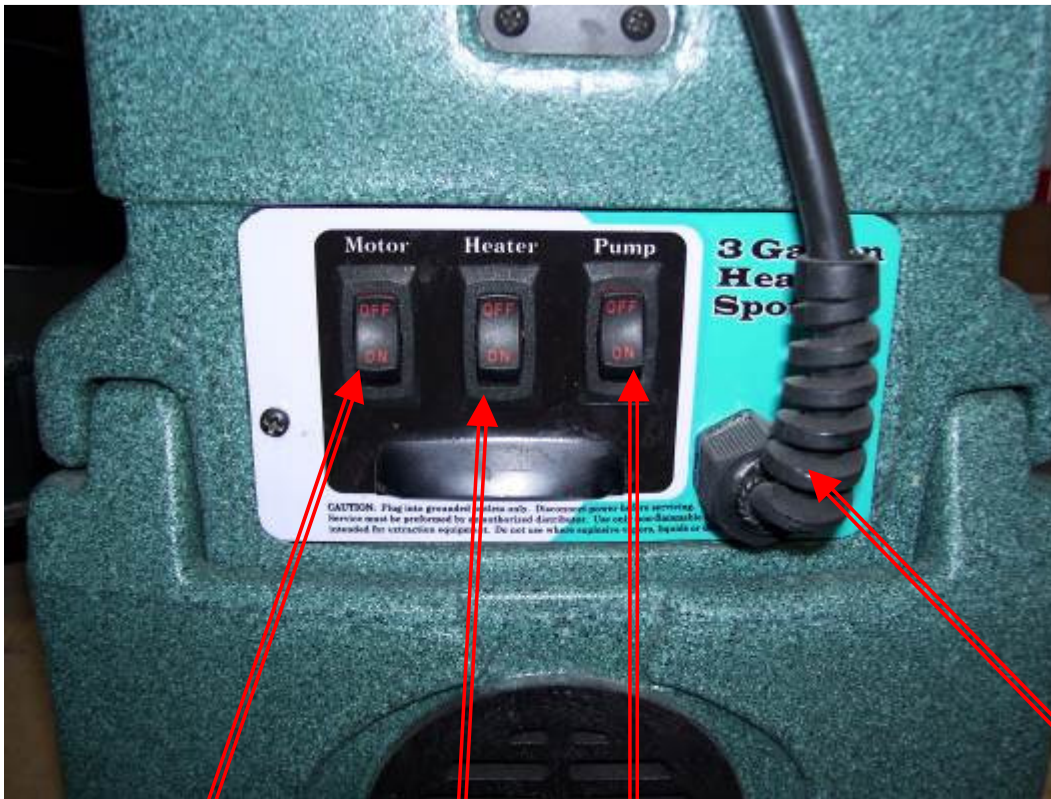

Vacuum Switch

When the switch is turned to the ON position power is supplied to the vacuum motor only.

Solution Pump Switch

When the switch is turned to the ON position power is supplied to the solution pump motor only.

When not using solution (Extracting only), do not turn this switch ON.

Heater Switch

When the switch is turned to the ON position power is supplied to the solution heater only. Always turn pump switch on first and be sure water is flowing to the tool before turning heater ON.

Turn heater off and spray tool for a minute to cool off heater before turning pump off.

When not using solution (Extracting only), do not turn this switch ON.

Power Cord

Item #	MA51H Component Description	Qty Needed
NM5090-ST	Solution Tank	1
NM5090-RT	Recovery Tank	1
10-0383	6/32 x ¼ Phil Pan Blk Screw (Latch & Switch Plate)	6
10-0400-D	Latch	1
10-0412	C Channel For Spotter	2
10-0414	Rivet For Spotter Handle	4
10-0384	.125 Thick Nylon Washer	4
10-0385	.06 Thick Nylon Washer	4
NM5032	Flat Washer #8 SAE	5
10-0216	Allen Head Screw	4
10-0379	8-32 x 3/8" Screw	4
10-0405	1½" PVC SCH40 Slip Thread	1
10-0302-A	Gasket Tank Hatch	1
10-0416-A	ABS Stand Pipe Black 1½"	1
10-0304	Spotter Cap And Float Assembly	1
10-0381	Float Only	1
10-0302	Tank Hatch & Rim Assembly Only	1
10-0419	Screw For Spotter Hatch	6
SP-3-HS-GRNGRAN	Base Spotter Skirt w/ Heat	1
10-0831	S/R Bracket	1
10-0832	S/R Strap Bolts	2
AP30	Pump For Spotter	1
BR070	Nipple 1/8" Hex Brass	1
PSA100901	Pressure Relief Valve 175psi	1
BR220	Brass Plug 1/8"	1
NM5087	Bulkhead Fitting 1/4" Brass	2
BR020	Barb 3/8" x 1/4" MPT Brass	4
PH07	Hose Clamp	6
10-0843	Hose 3/8" ID Black LP	1
10-0434	Threaded Hose for Spotter	1
NA0839	Barb Nylon Straight 1/8 NPT X 1/4" Barb	4
NA0840	1/8" Strainer for Spotter	1
10-0301	L Bracket For Spotter	1
10-0828	90 Deg Brass Elbow 1/8" MPT	1
10-0022	Screw	3
10-0017	Deflector Screw	1
PA076	Female Spade Connector Insulated – Blue	10
T-WPUR	Purple Wire	
BR282	Elbow 90 Deg 1/4" Street M-F	1
BR252	Tee 1/4" Street M-F-F	1
10-0843	Hose 3/8" ID Black LP	1
BR292	Elbow 90 Deg 1/4" F-F	1
NM5069	Check Valve 1/4" MPT	1
80-0014	Elbow 90 Deg 1/4" FPT x 3/8" barb	1
BR082	1/4" Close Nipple Brass	1
AH102B	1/4" Male Quick Connect	1
PSA101500B	Heater – Element Only	1
10-0814-B	Temperature Switch Auto Reset	1
10-0814	Temperature Switch Manual Reset	1
10-0907	Strain Relief for Heater	1

Item #	MA51H Component Description	Qty Needed
10-0906	Heater Box Only	1
10-0900	Heater Body Only	1
10-0801-G	Insulation for Heater Box	1
PSA100910	Heater Assembly Complete with all Fittings & Temperature Switches	1
SP-3-H-BLK	Handle - Black	1
NM5090-HANDLE	Handle Assembly (Includes hardware)	1
10-0387	5/16 x 1" Socket Head Bolt (For Wheels)	2
10-0303	Roller Blade Wheel	2
10-0822	Exhaust Grate	2
10-0419-A	Screw For Exhaust Grate	2
10-0014	Motor Screws	2
10-0380	Screw 10-32 x 3/8"	2
10-1024	Vac Motor Mounting Plate	1
AV06	Vacuum Motor	1
10-0386	Stamped Motor Screen	1
10-1030	Spotter Motor Gasket	1
10-0027-A	Strain Relief Nut For Spotter	1
T-WBLA	Black Wire	
10-0027	Pigtail Strain Relief Spotter	1
10-0448-B	20 Ft. Spotter/Air Mover Cord	1
PDR101	On/Off Rocker Switch	3
10-1026	Back Switch Plate (with heater)	1
10-0400-C	Latch Keeper 10-0400-C	1
NM4061	Screw 10-32 x 1/2" BH SOC SS	3
NM4255	Washer Flat #10 SS	2
NM4081	NUT 10-32 NYLOCK SS	1

MA51H

VACUUM FILTER
10-0431



SPOTTER HATCH COVER
BOTTOM VIEW



SPOTTER HATCH & COVER
10-0302
GASKET – 10-0302-A
SCREWS – 10-0419 (QTY 6)

SPOTTER HANDLE ASSEMBLY
NM5090-HANDLE
HANDLE SLIDE ASSEMBLY
50-0001A



SOLUTION TANK
NM5090-ST



SPOTTER COVER & FLOAT
10-0304
FLOAT ONLY
10-0381

RECOVERY TANK
NM5090-RT

SPOTTER BASE W/ HEAT
SP-3-HS-GRNGRAN

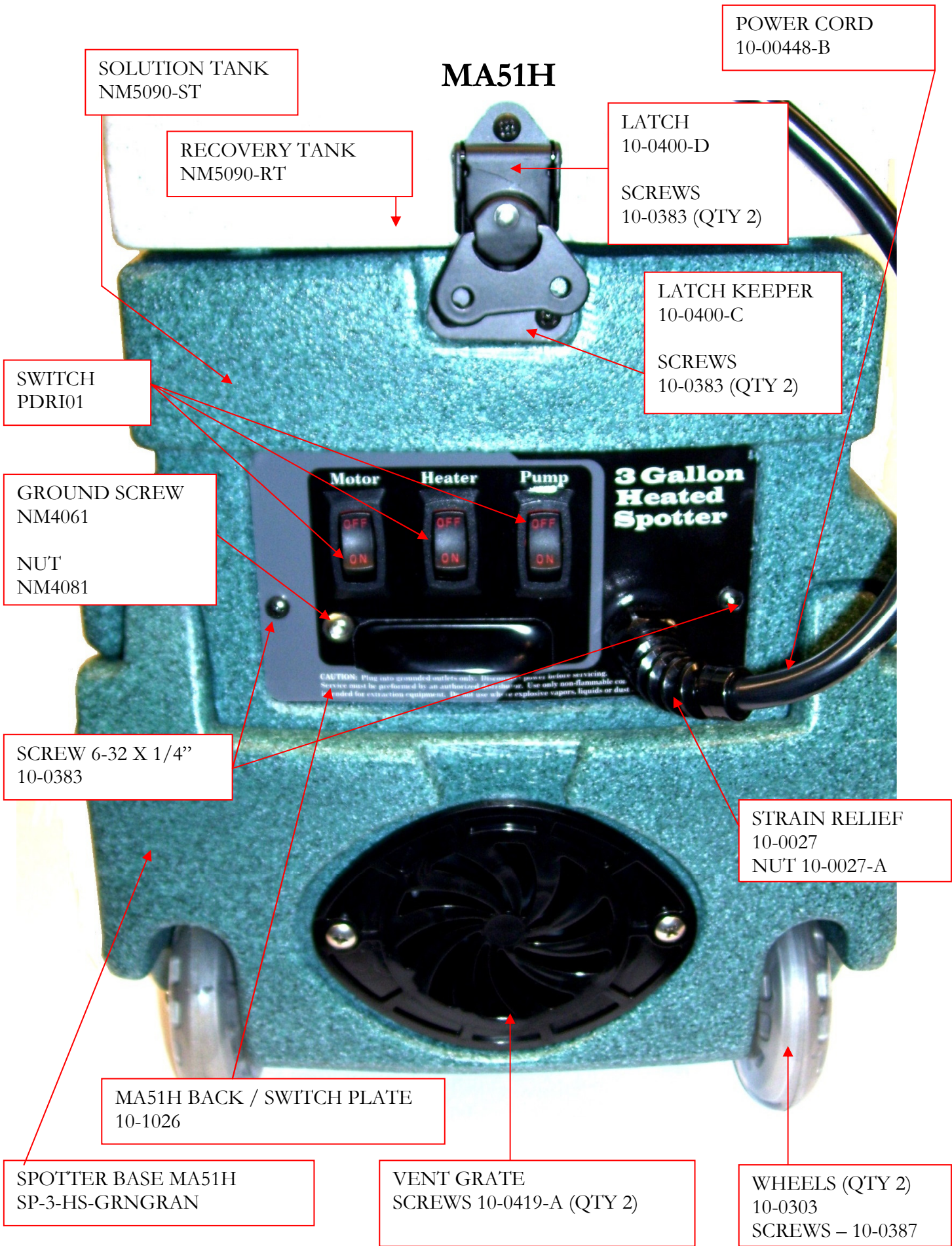

SOLUTION TANK
NM5090-ST

RECOVERY TANK
NM5090-RT

LATCH
10-0400-D
SCREWS
10-0383 (QTY 2)

POWER CORD
10-00448-B

LATCH KEEPER
10-0400-C
SCREWS
10-0383 (QTY 2)

SWITCH
PDRI01

GROUND SCREW
NM4061
NUT
NM4081

SCREW 6-32 X 1/4"
10-0383

STRAIN RELIEF
10-0027
NUT 10-0027-A

MA51H BACK / SWITCH PLATE
10-1026

SPOTTER BASE MA51H
SP-3-HS-GRN GRAN

VENT GRATE
SCREWS 10-0419-A (QTY 2)

WHEELS (QTY 2)
10-0303
SCREWS - 10-0387

MA51H

SCREW VAC MOTOR MOUNT (QTY 2)
10-0014

HOSE 3/8" ID HI-TEMP BLACK

PUMP
AP30

1/8" HEX NIPPLE
BR070

BARB 3/8" X 1/4" MPT
BR020

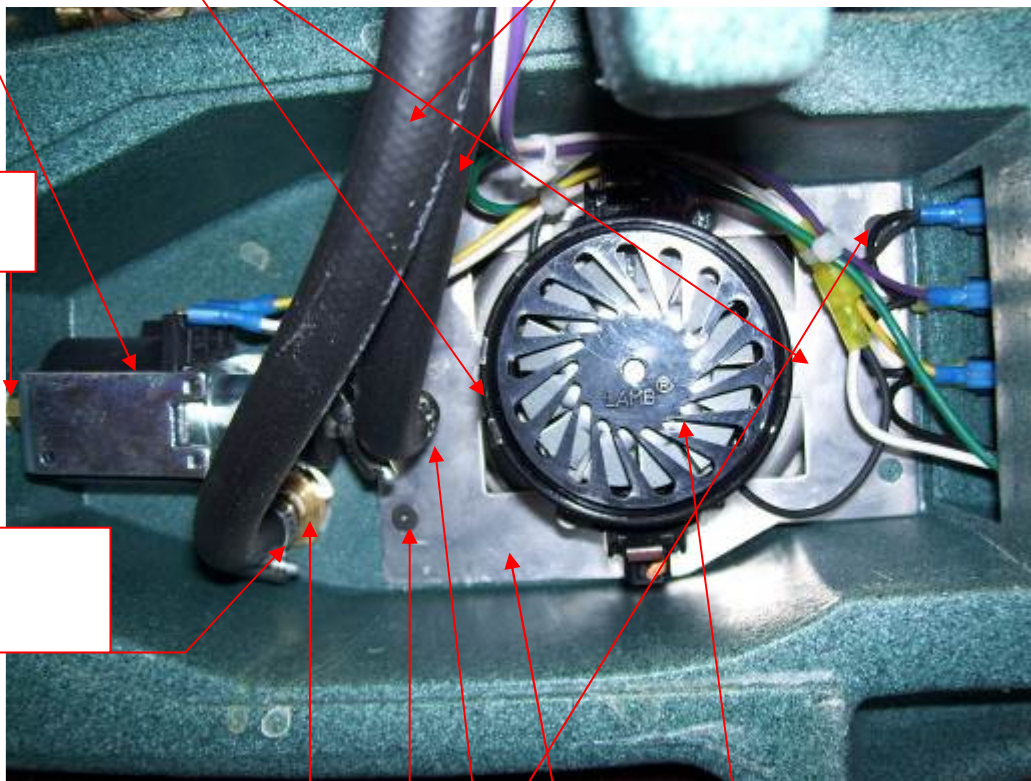

BULKHEAD FITTING 1/4"
NM5087

VACUUM MOTOR
AV06

SCREW VAC MOUNT PLATE (QTY 2)
10-0380

PLATE VAC MOTOR MOUNT

90 DEGREE BRASS ELBOW 3/8" BARB X 1/8" MPT
10-0828

VACUUM GASKET
10-1030

SOLUTION TANK
NM5090-ST

VACUUM SCREEN
10-0386

VACUUM MOTOR
AV06

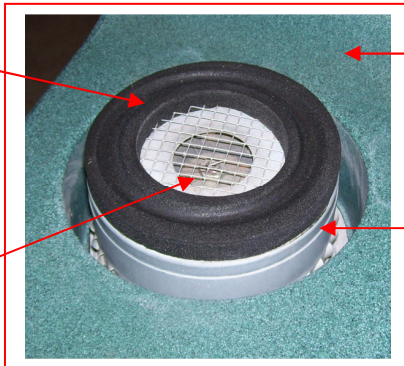

MA51H New Heater Assembly

Heater is secured to Spotter Base with two screws & Flat Washers:
 2 - SCREW 10-32 x 1/2" BH SOC SS – NM4061
 2 - WASHER FLAT #10 SS – NM4255

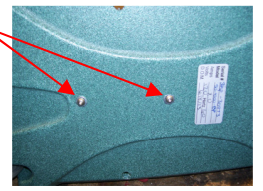

HOSE HP 1/4" ID HI-TEMP BLUE
 1/4" T F FLARE FITTINGS

HOSE LP 3/8" ID HI-TEMP BLACK
 10-0843 (Sold per inch)

BARB 3/8" X 1/4" MPT
 BR020

ADAPTER 1/4" MPT X 1/4" T M FLARE
 BR126

PRESSURE RELIEF VALVE
 PSA100901

CHECK VALVE 1/4" MPT
 NM5069

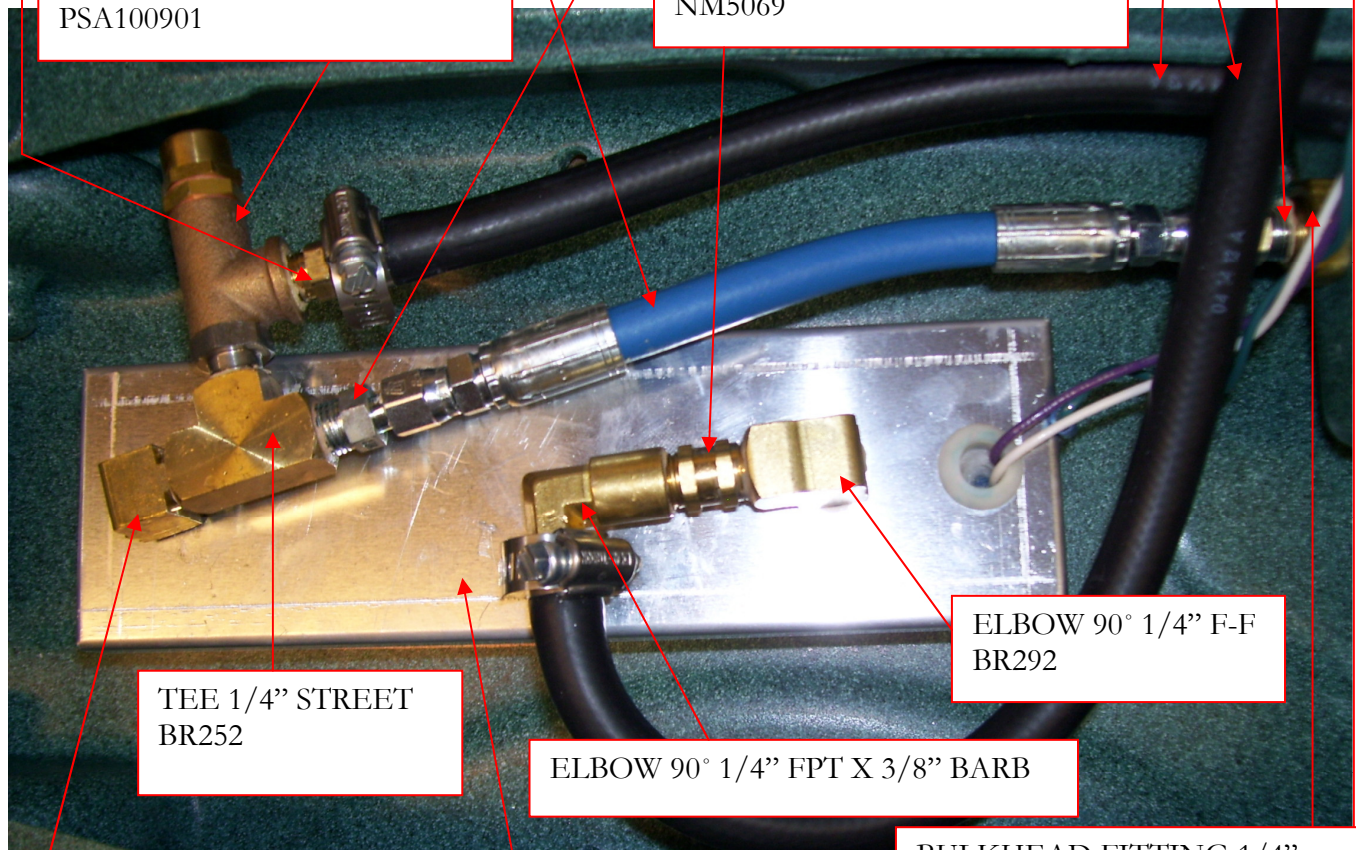

ELBOW 90° 1/4" F-F
 BR292

TEE 1/4" STREET
 BR252

ELBOW 90° 1/4" FPT X 3/8" BARB

ELBOW 90° 1/4" STREET
 BR282

HEATER 600W
 PSA100910
 COMPLETE WITH FITTINGS

BULKHEAD FITTING 1/4"
 NM5087

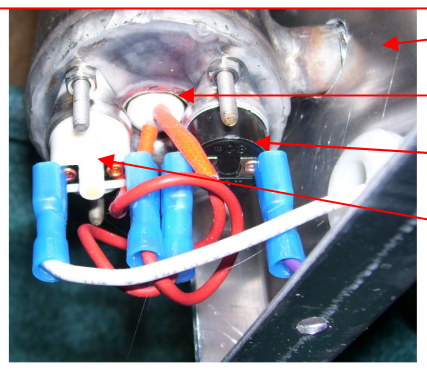

HEATER OUTER SHELL ONLY – PSA100900

HEATER ELEMENT ONLY – PSA101500B

TEMPERATURE SWITCH AUTO RESET
 10-0814-B

TEMPERATURE SWITCH MANUAL RESET
 10-0814

MA51H Old Style Heater

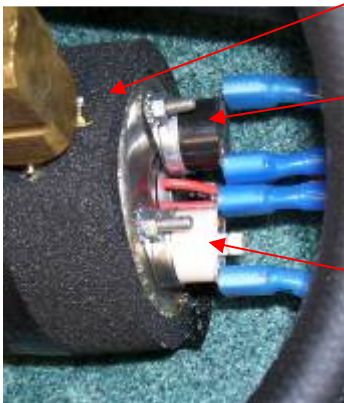
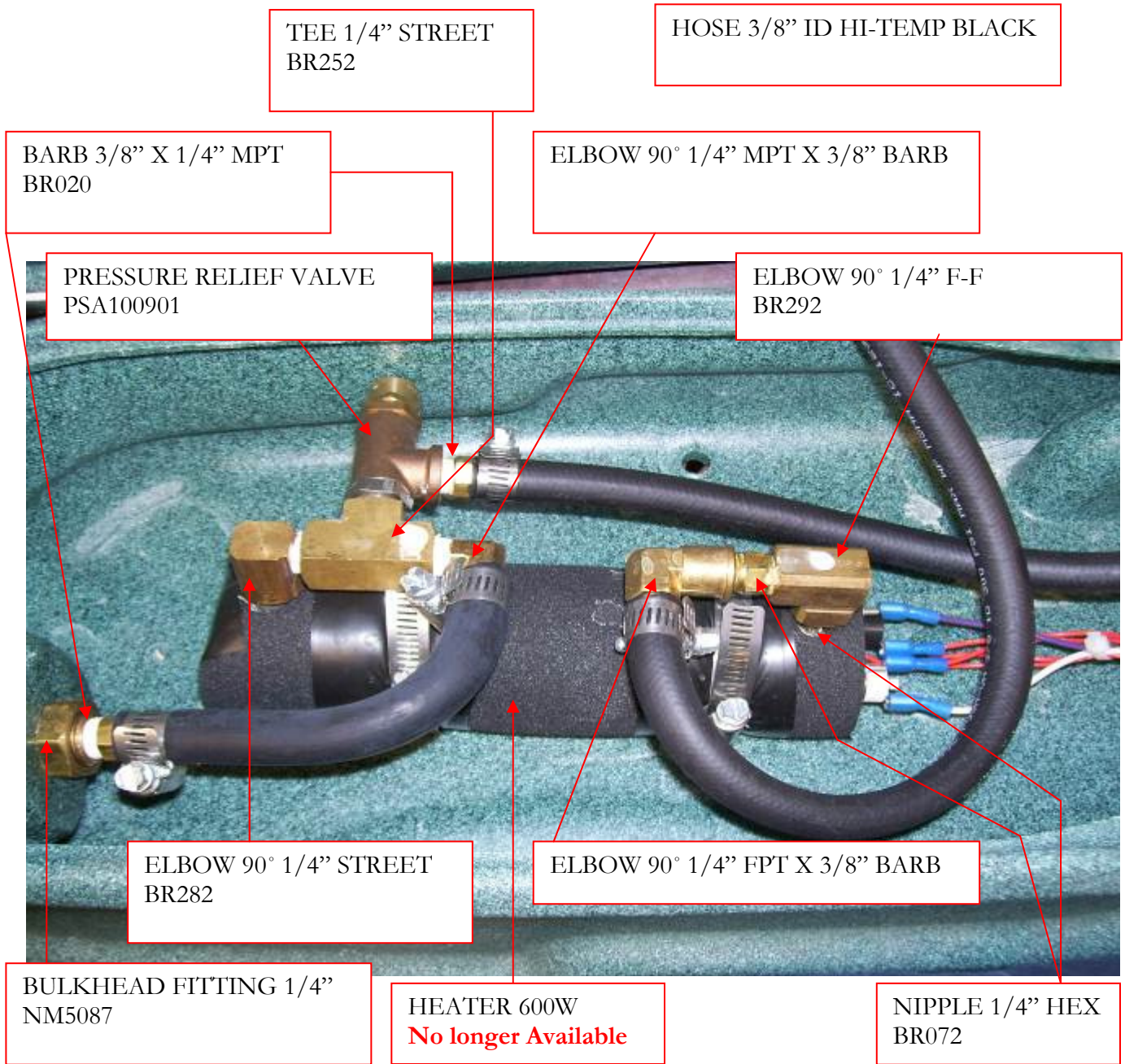

TEMPERATURE SWITCH AUTO RESET
10-0814-B

TEMPERATURE SWITCH MANUAL RESET
10-0814

MA51H

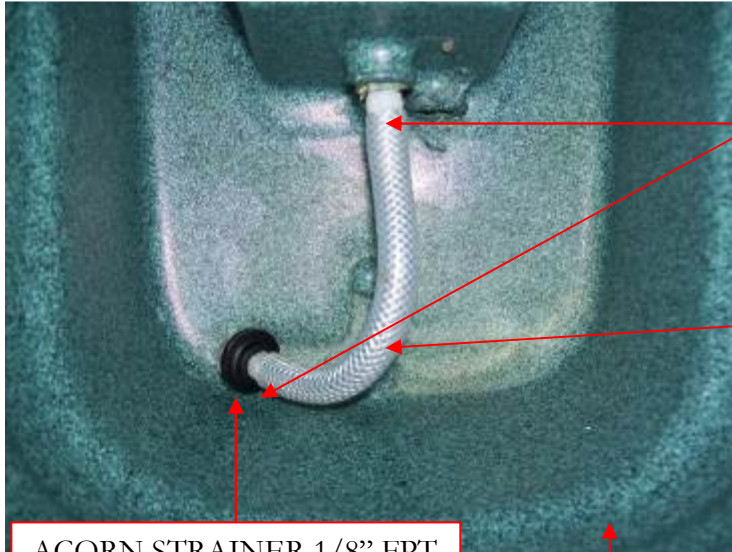

BARB 1/4" X 1/8" MPT
NA0839

1/4" ID HOSE
10-0434

ACORN STRAINER 1/8" FPT
NA0840

RECOVERY TANK
NM5090-RT

SOLUTION TANK
NM5090-ST



SPOTTER BASE MA51H
SP-3-HS-GRNGRAN

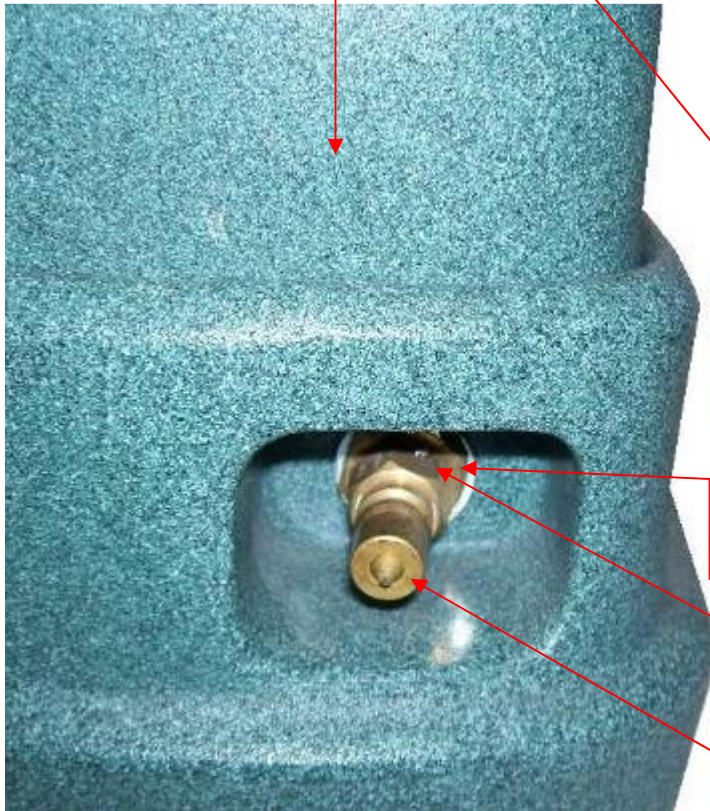

BULKHEAD FITTING 1/4"
NM5087

NIPPLE 1/4" HEX
BR072

1/4" MALE QUICK CONNECT
AH102B

AW55H HOSE & TOOL ASSEMBLY

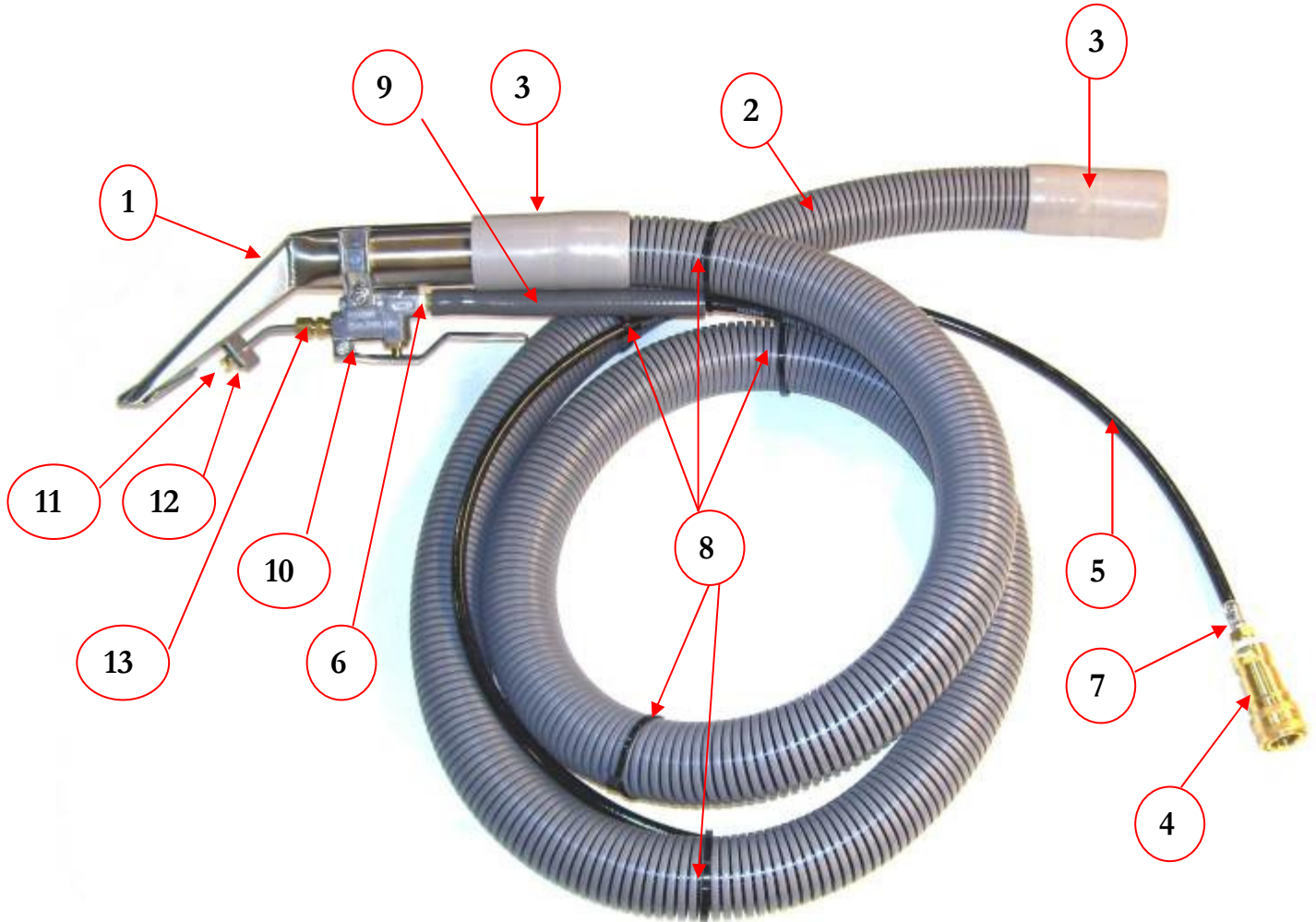

	ITEM#	Description	QTY
1	PA205	3.5" SS Upholstery Tool	1
2	AH35	1-1/4" Gray Vacuum Hose (Sold per foot)	7'
3	PP08-805088	1-1/4" Hose Cuff	2
4	AH101B	1/4" QD Female	1
5	NA40A	3/16" HP Black Solution Hose (Sold per Inch)	96"
6	AH01	1/8" Hose End for 3/16" hose	1
7	AH02	1/4" Hose End for 3/16" hose	1
8	100003	Wire Tie Black 7"	5
9	AH90	3/8" LP Gray Solution Hose (Sold per foot)	0.5
10	PMV124V5	Solution Valve with lever & mounting bracket	1
11	PMF8002	Tee Jet for hand tool 8002	1
12	PMF011	Retaining Plate for jet on hand tool	1
13	BR304	Compression fitting 1/8" MPT	1
NS	PMV124V5B	Valve Repair Kit	1