

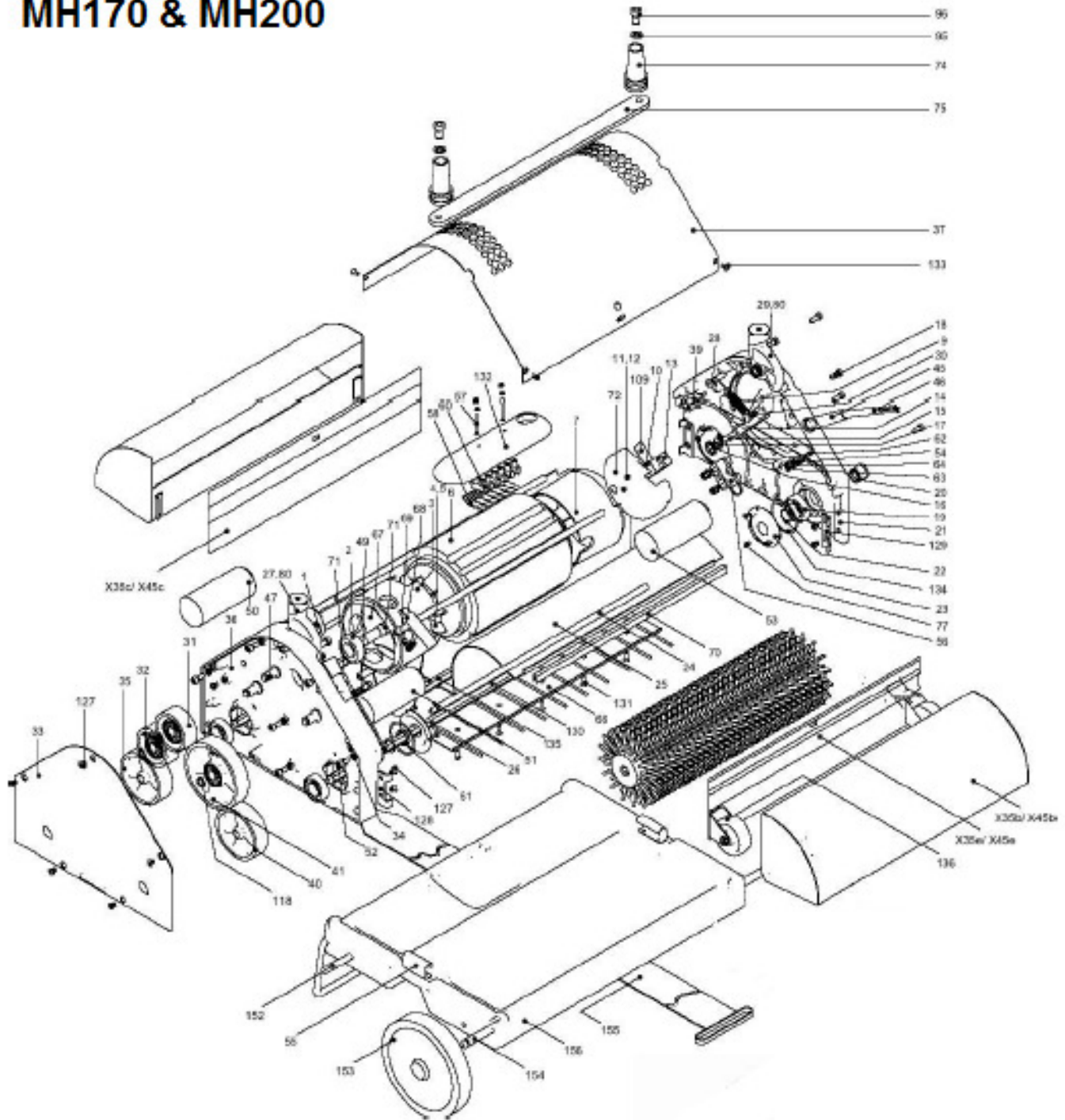

BRUSH PRO 17LM & 20LM PARTS

MH170 & MH200

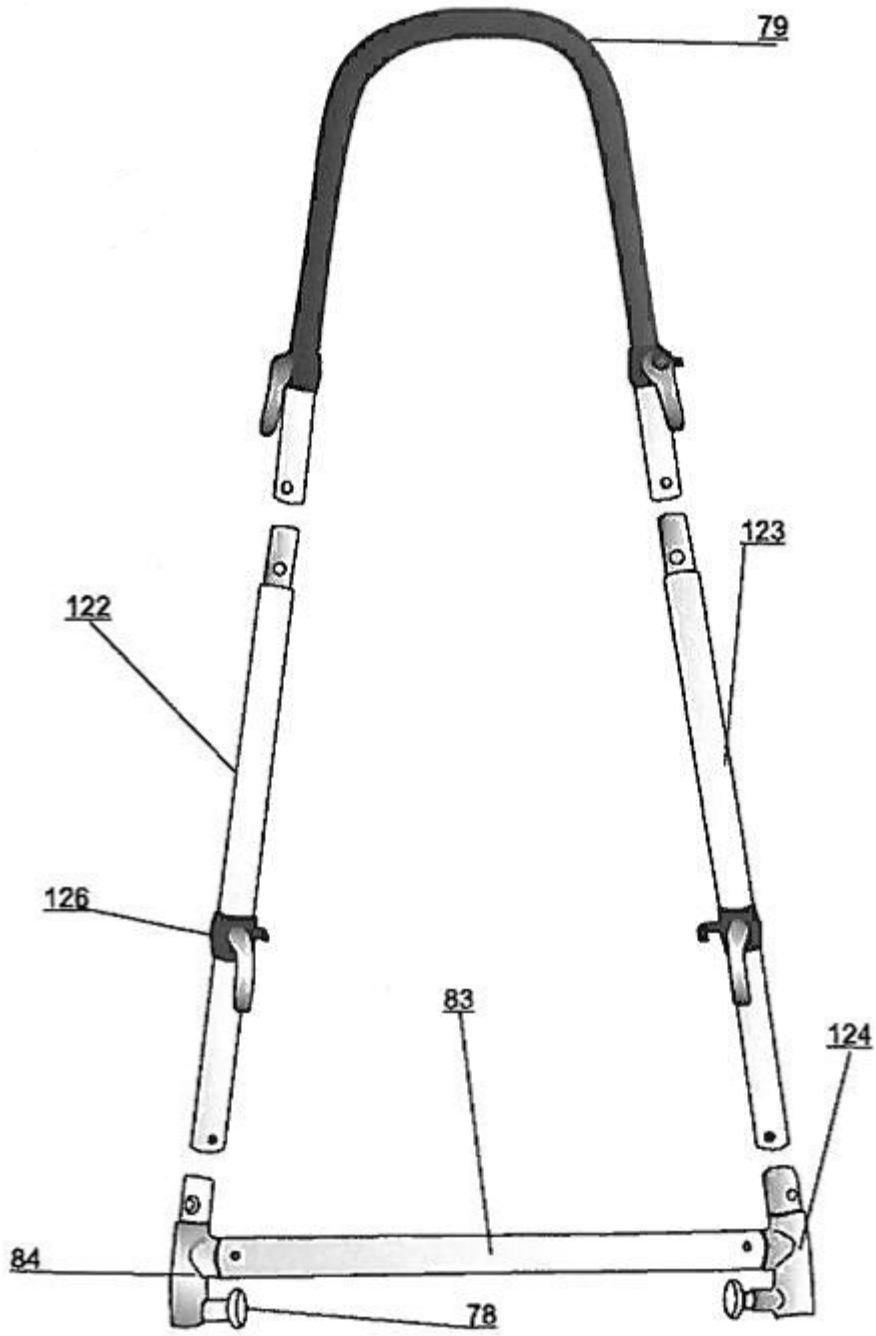



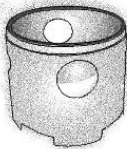







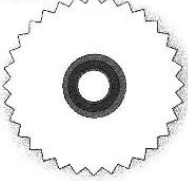
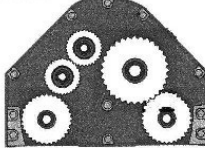
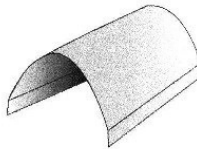

Parts - Brush Pro 17LM & 20LM

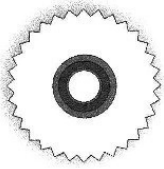
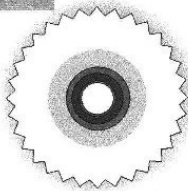
<p>1</p> 	<p>2</p> 	<p>3</p> 	<p>4</p> 
<p>NM5200 Snapring A 12</p>	<p>NM5202 Ballbearing</p>	<p>Distancepiece G NM5201 - BRUSH PRO 17LM NM5371 - BRUSH PRO 20LM</p>	<p>NM5203 Split pin 3 x 20 A2</p>
<p>5</p> 	<p>6</p> 	<p>7</p> 	<p>9</p> 
<p>NM5205 Ventilator</p>	<p>Motor Brush Pro 17LM NM5207 Motor Brush Pro 20LM NM5373</p>	<p>Distancepiece E NM5209 BRUSH PRO 17LM NM5374 BRUSH PRO 20LM</p>	<p>NM5211 Extension spring 10x 1,2 x 64</p>
<p>10</p> 	<p>11</p> 	<p>12</p> 	<p>13</p> 
<p>NM5213 Grub screw M3 x 40</p>	<p>NM5215 Nut M3 Ms</p>	<p>NM5217 Spring Ring M3</p>	<p>NM5206 Microswitch</p>
<p>14</p> 	<p>15</p> 	<p>16</p> 	<p>17</p> 
<p>NM5208 Switchpart cpl.</p>	<p>NM5221 Grub screw M5 x 25</p>	<p>NM5223 Nut M5</p>	<p>NM5225 Disc M5</p>





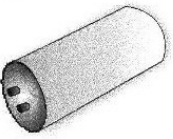
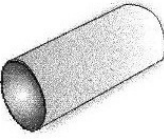

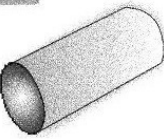



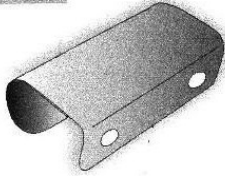
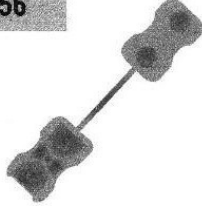

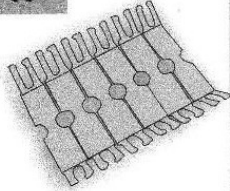
Parts - Brush Pro 17LM & 20LM

<p>18</p> 	<p>19</p> 	<p>20</p> 	<p>21</p> 
<p>NM5227 Cylinder head screw M5 x 12</p>	<p>NM5210 Ballbearing</p>	<p>NM5212 Flange</p>	<p>NM5229 Housing unit E complet</p>
<p>22</p> 	<p>23</p> 	<p>24</p> 	<p>25</p> 
<p>NM5214 Snapping 16 x 1</p>	<p>NM5282 Protective plat</p>	<p>Motorstud NM5233 - BRUSH PRO 17LM NM5375 - BRUSH PRO 20LM</p>	<p>Brushcover NM5235 - BRUSH PRO 17LM NM5376 - BRUSH PRO 20LM</p>
<p>26</p> 	<p>27</p> 	<p>28</p> 	<p>29</p> 
<p>Brush axle NM5216 - BRUSH PRO 17LM NM5377 - BRUSH PRO 20LM</p>	<p>NM5218 Handle connector lower part G</p>	<p>NM5237 Cylinder head screw M6 x 16</p>	<p>NM5219 Handle connector lower part E</p>
<p>30</p> 	<p>31</p> 	<p>32</p> 	<p>33</p> 
<p>NM5239 Cylinder head screw M6 x 16</p>	<p>NM5220 Gear 48 right</p>	<p>NM5222 Gear 48 left</p>	<p>NM5241 Gearcover</p>

Parts - Brush Pro 17LM & 20LM

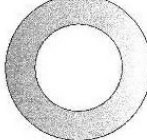
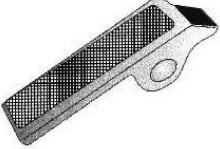
<p>34</p> 	<p>35</p> 	<p>36</p> 	<p>37</p> 
<p>NM5243 Lock washer M5</p>	<p>NM5224 Gear 66 right</p>	<p>NM5245 Housing unit G cpl.</p>	<p>Motor Cover w/ Power Outlet NM5247 - BRUSH PRO 17LM NM5378 - BRUSH PRO 20LM</p>
<p>39</p> 	<p>40</p> 	<p>41</p> 	<p>42</p> 
<p>NM5226 Thermorelay</p>	<p>NM5228 Gear 66 left</p>	<p>NM5230 Gear 85 right</p>	<p>NM5232 Ball Bearing 6000</p>
<p>45</p> 	<p>46</p> 	<p>47</p> 	<p>49</p> 
<p>NM5234 Grommet</p>	<p>NM5236 Cable</p>	<p>NM5249 Bearingpin</p>	<p>NM5251 Cylinder head screw M4 x 8</p>
<p>50</p> 	<p>51</p> 	<p>52</p> 	<p>53</p> 
<p>NM5238 Run capacitor</p>	<p>NM5253 Starting capacitor</p>	<p>NM5255 Cylinder head screw M5 x 12</p>	<p>NM5257 Starting control</p>

Parts - Brush Pro 17LM & 20LM

<p>54</p> 	<p>55</p> 	<p>56</p> 	<p>57</p> 
<p>NM5269 Clamp strip</p>	<p>NM5261 Fixing spring</p>	<p>NM5263 Cable clamp</p>	<p>NM5265 Cylinder head screw M3 x 25</p>
<p>58</p> 	<p>60</p> 	<p>61</p> 	<p>62</p> 
<p>NM5267 wire fixing plate</p>	<p>NM5269 terminal</p>	<p>NM5271 V-ring</p>	<p>NM5273 Wormscrew</p>
<p>63</p> 	<p>64</p> 	<p>66</p> 	<p>67</p> 
<p>NM5276 Nut M4</p>	<p>NM5277 Lock washer M4 A2</p>	<p>Cableprotector NM5240 - BRUSH PRO 17LM NM5379 - BRUSH PRO 20LM</p>	<p>NM5279 Blind</p>
<p>68</p> 	<p>69</p> 	<p>70</p> 	<p>71</p> 
<p>NM5242 Handle stop</p>	<p>NM5244 Handle stop - spring</p>	<p>Seal (Cover) NM5281 - BRUSH PRO 17LM NM5381 - BRUSH PRO 20LM</p>	<p>NM5283 Snapping A 15</p>

Parts - Brush Pro 17LM & 20LM

<p>74</p> 	<p>75</p> 	<p>E 76</p> 	<p>77</p> 
<p>NM5287 Handle connector upper part</p>	<p>Flatbar NM5289 - BRUSH PRO 17LM NM5386 - BRUSH PRO 20LM</p>	<p>NM5291 Washer Disc</p>	<p>NM5293 Screw M3 x 5</p>
<p>78</p> 	<p>79</p> 	<p>80</p> 	<p>83</p> 
<p>NM5295 Snap - in</p>	<p>NM5297 Handle, upper part</p>	<p>non-stock Bearing</p>	<p>Cross bar NM5301 - BRUSH PRO 17LM NM5387 - BRUSH PRO 20LM</p>
<p>84</p> 	<p>85</p> 	<p>86-35/45</p> 	<p>88</p> 
<p>NM5303 T-piece left</p>	<p>non-stock Cable holder left</p>	<p>Tandem Bar NM5305 - BRUSH PRO 17LM NM5388 - BRUSH PRO 20LM</p>	<p>Handle complete NM5307 - BRUSH PRO 17LM NM5389 - BRUSH PRO 20 LM</p>
<p>95</p> 	<p>96</p> 	<p>106</p> 	<p>113</p> 
<p>NM5309 Spring Ring M6</p>	<p>NM5311 Screw M6 x 30</p>	<p>non-stock Isolating plate</p>	<p>non-stock Screw M6 x 16</p>

Parts - Brush Pro 17LM & 20LM

<p>116</p> 	<p>118</p> 	<p>120</p> 	<p>122</p> 
<p>non-stock Spring Ring</p>	<p>NM5200 Snapping A 12</p>	<p>non-stock Screw M6 x 16</p>	<p>NM5323 Handle, lower part left</p>
<p>123</p> 	<p>124</p> 	<p>126</p> 	<p>127</p> 
<p>NM5325 Handle, lower part right</p>	<p>NM5327 T-piece right</p>	<p>NM5246 Cable holder right</p>	<p>NM5329 Countersunk-head screw M5 x 6</p>
<p>128</p> 	<p>129</p> 	<p>130</p> 	<p>131</p> 
<p>NM5331 Holder left</p>	<p>NM5333 Holder right</p>	<p>Throw-in accelerator NM5335 - BRUSH PRO 17LM NM5396 - BRUSH PRO 20LM</p>	<p>NM5337 Countersunk-head screw M4 x 12</p>
<p>132</p> 	<p>133</p> 	<p>134</p> 	<p>135</p> 
<p>NM5339 Protective cover</p>	<p>NM5341 Countersunk-head screw M4 x 8</p>	<p>NM5343 O-ring</p>	<p>Cable protector NM5345 - BRUSH PRO 17LM NM5397 - BRUSH PRO 20LM</p>

Parts - Brush Pro 17LM & 20LM

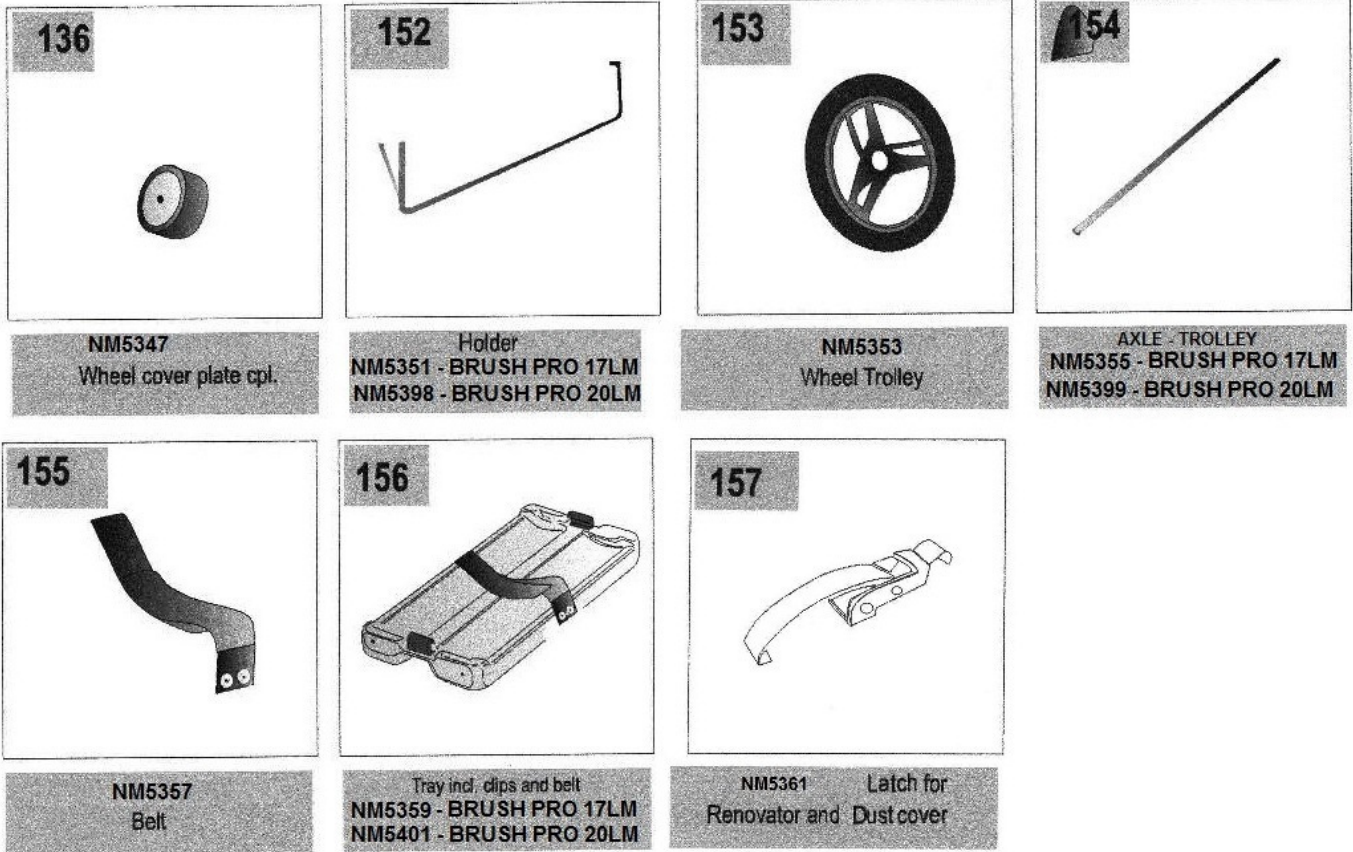

X45B – NM5409 – Renovator - Dirt Receptacles Brush Pro 20LM (Set of Two)
 X45C – NM5411 – Dust Cover without Wheels Brush Pro 20LM (One Only)
 X45D – NM5415 – Transport Trolley Complete Brush Pro 20LM
 X45E – NM5413 – Dust Covers with Wheels Brush Pro 20LM (One Only)

X35B – NM5363 - Renovator - Dirt Receptacles Brush Pro 17LM (Set of Two)
 X35C – NM5365 - Dust Cover without Wheels Brush Pro 17LM (One Only)
 X35D – NM5369 - Transport Trolley Complete Brush Pro 17LM
 X35E – NM5367 - Dust Covers with Wheels Brush Pro 17LM (One Only)

G109 – NM5313 – Isolation Plate
 G149 – NM5349 – Pig Tail Cable