

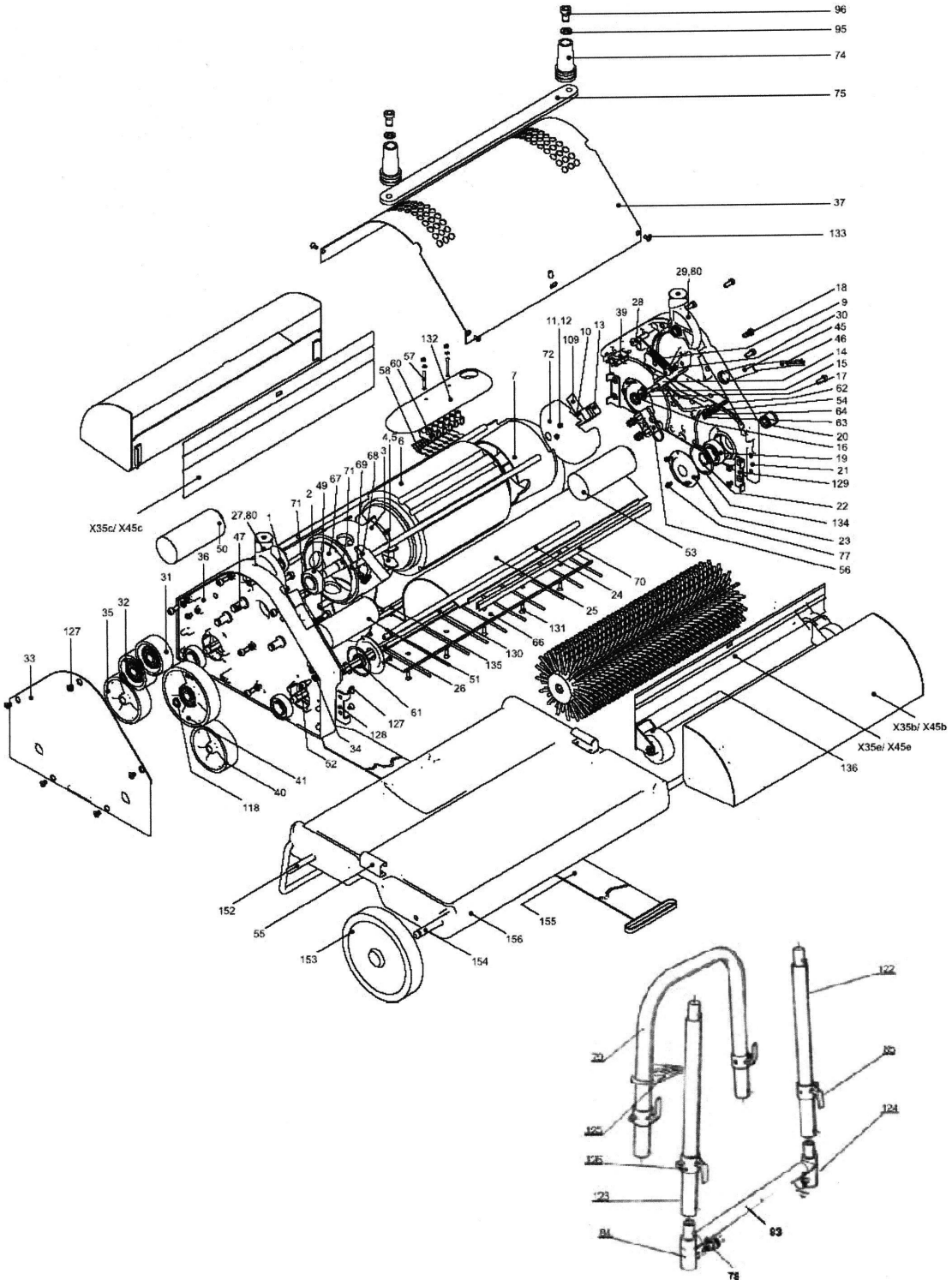







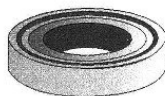

**Parts - Brush Pro 17LM (MH53)
Brush Pro 20LM (MH54)**

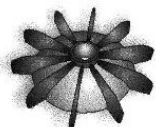
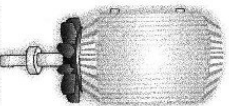
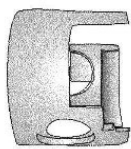



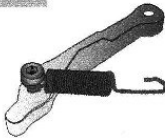



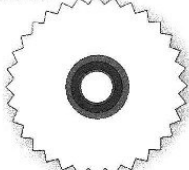
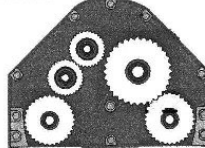
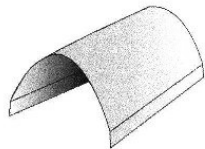

Parts - Brush Pro 17LM & 20LM

<p>1</p> 	<p>2</p> 	<p>3</p> 	<p>4</p> 
<p>NM5200 Snapping A 12</p>	<p>NM5202 Ballbearing</p>	<p>Distancepiece G</p>	<p>Split pin 3 x 20 A2</p>
<p>5</p> 	<p>6</p> 	<p>7</p> 	<p>9</p> 
<p>Ventilator</p>	<p>Motor RBF 0,18/2-PR</p>	<p>Distancepiece E</p>	<p>Extension spring 10x 1,2 x 64</p>
<p>10</p> 	<p>11</p> 	<p>12</p> 	<p>13</p> 
<p>Grub screw M3 x 40</p>	<p>Nut M3 Ms</p>	<p>Spring Ring M3</p>	<p>Microswitch</p>
<p>14</p> 	<p>15</p> 	<p>16</p> 	<p>17</p> 
<p>NM5208 Switchpart cpl.</p>	<p>Grub screw M5 x 25</p>	<p>Nut M5</p>	<p>Disc M5</p>

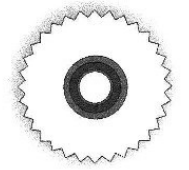
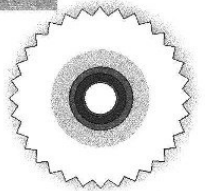

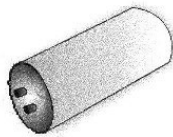
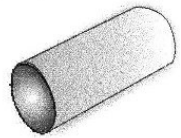

Parts - Brush Pro 17LM & 20LM

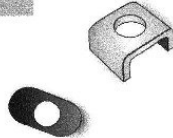
<p>18</p> 	<p>19</p> 	<p>20</p> 	<p>21</p> 
<p>Cylinder head screw M5 x 12</p>	<p>NM5210 Ballbearing</p>	<p>NM5212 Flange</p>	<p>Housing unit E complet</p>
<p>22</p> 	<p>23</p> 	<p>24</p> 	<p>25</p> 
<p>NM5214 Snapping 16 x 1</p>	<p>NM5282 Protective plat</p>	<p>Motorstud</p>	<p>Brushcover</p>
<p>26</p> 	<p>27</p> 	<p>28</p> 	<p>29</p> 
<p>NM5216 Brush axle</p>	<p>NM5218 Handle connector lower part G</p>	<p>Cylinder head screw M6 x 16</p>	<p>NM5219 Handle connector lower part E</p>
<p>30</p> 	<p>31</p> 	<p>32</p> 	<p>33</p> 
<p>Cylinder head screw M6 x 16</p>	<p>NM5220 Gear 48 right</p>	<p>NM5222 Gear 48 left</p>	<p>Gearcover</p>

Parts - Brush Pro 17LM & 20LM

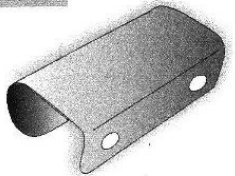
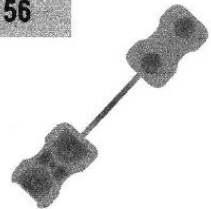
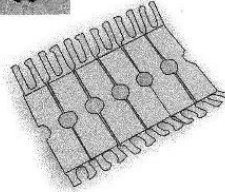
<p>34</p> 	<p>35</p> 	<p>36</p> 	<p>37</p> 
<p>Lock washer M5</p>	<p>NM5224 Gear 66 right</p>	<p>Housing unit G cpl.</p>	<p>motor cover</p>
<p>39</p> 	<p>40</p> 	<p>41</p> 	<p>45</p> 
<p>NM5226 Thermorelay</p>	<p>NM5228 Gear 66 left</p>	<p>Gear 85 right</p>	<p>NM5234 Grommet</p>
<p>46</p> 	<p>47</p> 	<p>49</p> 	<p>50</p> 
<p>NM5236 Cable</p>	<p>Bearingpin</p>	<p>Cylinder head screw M4 x 8</p>	<p>NM5238 Run capacitor</p>
<p>51</p> 	<p>52</p> 	<p>53</p> 	<p>54</p> 
<p>Starting capacitor</p>	<p>Cylinder head screw M5 x 12</p>	<p>Starting control</p>	<p>Clamp strip</p>

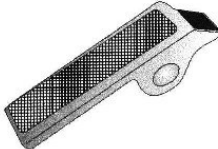
Parts - Brush Pro 17LM & 20LM

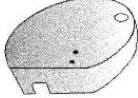
<p>55</p> 	<p>56</p> 	<p>57</p> 	<p>58</p> 
<p>Fixing spring</p>	<p>Cable clamp</p>	<p>Cylinder head screw M3 x 25</p>	<p>wire fixing plate</p>
<p>60</p> 	<p>61</p> 	<p>62</p> 	<p>63</p> 
<p>terminal</p>	<p>V-ring</p>	<p>Wormscrew</p>	<p>Nut M4</p>
<p>64</p> 	<p>66</p> 	<p>67</p> 	<p>68</p> 
<p>Lock washer M4 A2</p>	<p>NM5240 Cableprotector</p>	<p>Blind</p>	<p>NM5242 Handle stop</p>
<p>69</p> 	<p>70</p> 	<p>71</p> 	<p>72</p> 
<p>NM5244 Handle stop - spring</p>	<p>Seal (Cover)</p>	<p>Snapping A 15</p>	<p>Switchcover</p>

Parts - Brush Pro 17LM & 20LM

<p>74</p> 	<p>75</p> 	<p>77</p> 	<p>78</p> 
<p>NM5274 Handle connector upper part</p>	<p>Flatbar</p>	<p>Screw M3 x 5</p>	<p>Snap - in</p>
<p>79</p> 	<p>83</p> 	<p>84</p> 	<p>85</p> 
<p>Handle, upper part</p>	<p>Cross bar</p>	<p>T-piece left</p>	<p>Cable holder left</p>
<p>88</p> 	<p>95</p> 	<p>96</p> 	<p>106</p> 
<p>NM5332 Handle complete</p>	<p>Spring Ring M6</p>	<p>Screw M6 x 30</p>	<p>Isolating plate</p>
<p>118</p> 	<p>122</p> 	<p>123</p> 	<p>124</p> 
<p>NM5200 Snapping A 12</p>	<p>Handle, lower part left</p>	<p>Handle, lower part right</p>	<p>T-piece right</p>

Parts - Brush Pro 17LM & 20LM

<p>126</p> 	<p>127</p> 	<p>128</p> 	<p>129</p> 
<p>NM5246 Cable holder right</p>	<p>Countersunk-head screw M5 x 6</p>	<p>Holder left</p>	<p>Holder right</p>
<p>130</p> 	<p>131</p> 	<p>132</p> 	<p>133</p> 
<p>Throw-in accelerator</p>	<p>Countersunk-head screw M4 x 12</p>	<p>Protective cover</p>	<p>Countersunk-head screw M4 x 8</p>
<p>134</p> 	<p>135</p> 	<p>136</p> 	<p>152</p> 
<p>O-ring</p>	<p>NM5276 Cableprotector</p>	<p>Wheel cover plate cpl.</p>	<p>Holder</p>
<p>153</p> 	<p>154</p> 	<p>155</p> 	<p>156</p> 
<p>NM5342 Wheel Trolley</p>	<p>NM6272 Axel</p>	<p>Belt</p>	<p>Tray incl. clips and belt</p>

Parts - Brush Pro 17LM & 20LM

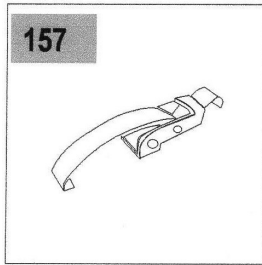

Latch for
Renovator and Dust cover

X45b – NM5350 – Renovator - Dirt Receptacles Brush Pro 20 & 20LM (Set of Two)

X45e – NM5352 – Dust Covers Brush Pro 20 & 20LM (Set of Two)